

ASOLE NEW

Art.-Nr.

359 848

↔	2400
↕	1700
↙	355
	mm

1/13

VO

01-2023

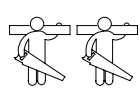

100 min

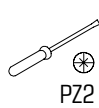

PZ2

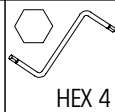

HEX 4

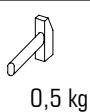

0,5 kg

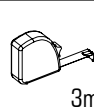

3m

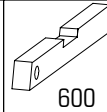

600



Ø8,10,12

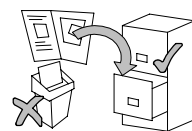
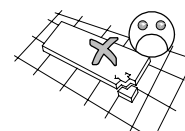
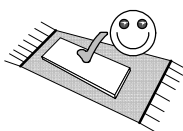
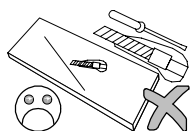
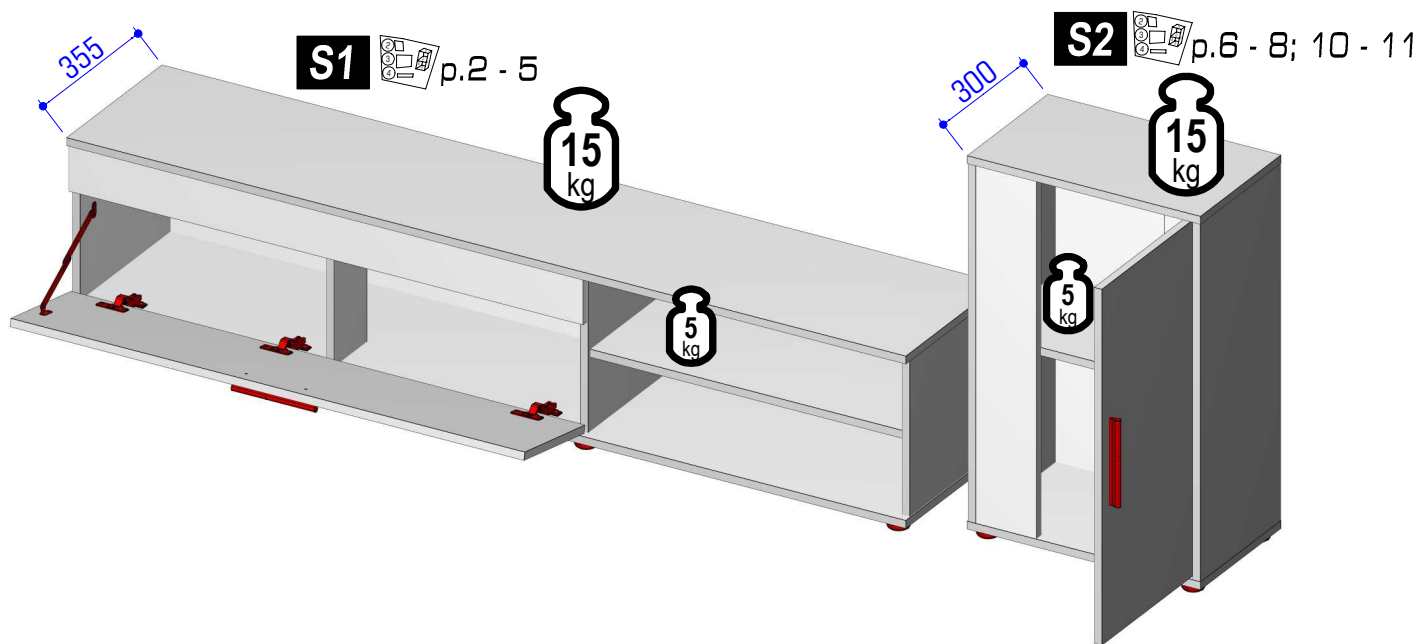
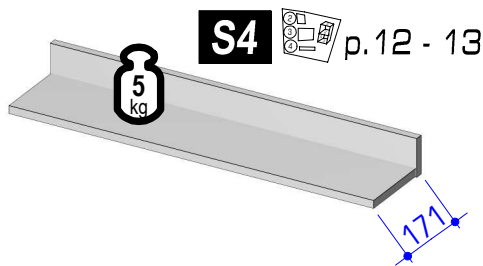
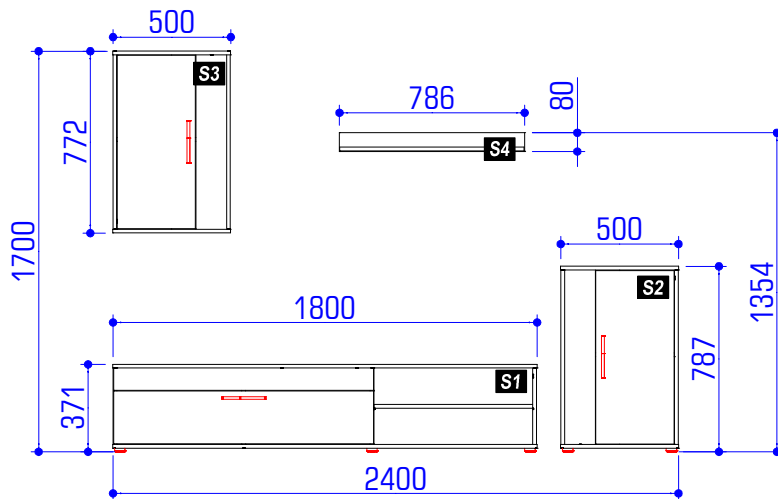
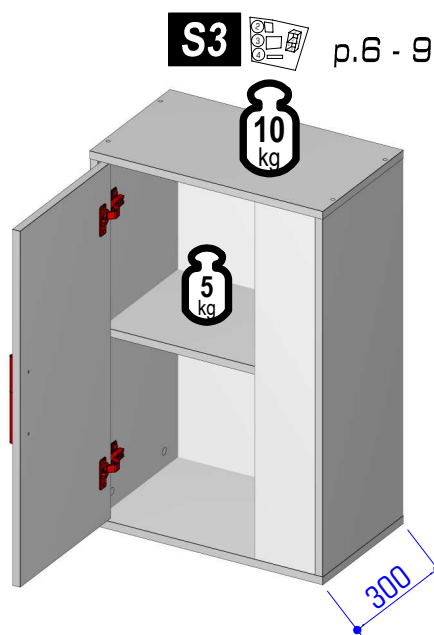

ASOLE NEW S1

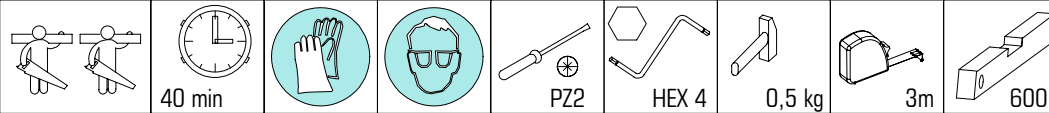

ID EE	ID	Dimensions	Quantity	Ratio
20048	③	1800*352*16	1x	1/2
20049	④	1800*352*16	1x	1/2
16977	⑤	324*332*16	1x	1/2
16978	⑥	324*332*16	1x	1/2
16979	⑦	324*332*16	1x	1/2
16980	⑧	674*324*16	1x	1/2
20050	⑨	1102*224*16	1x	1/2
20051	⑩	1102*94*16	1x	1/2
20052	⑪	1102*350*3	1x	1/2
20047	⑫	324*120*16	1x	1/2

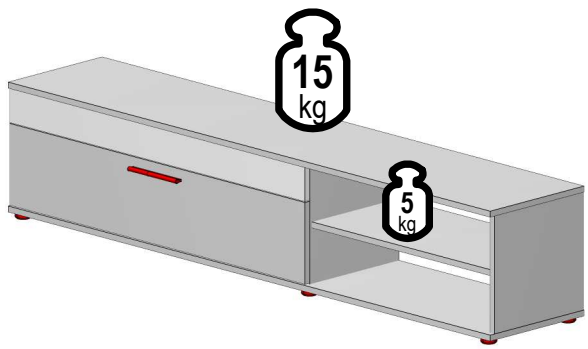

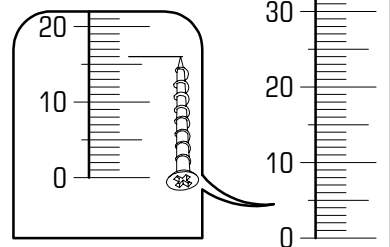
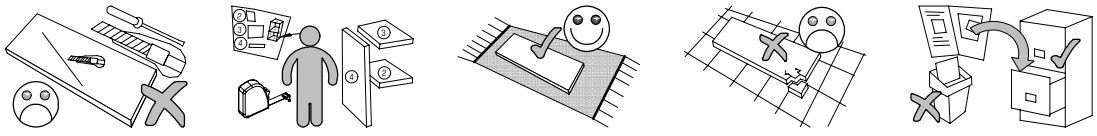
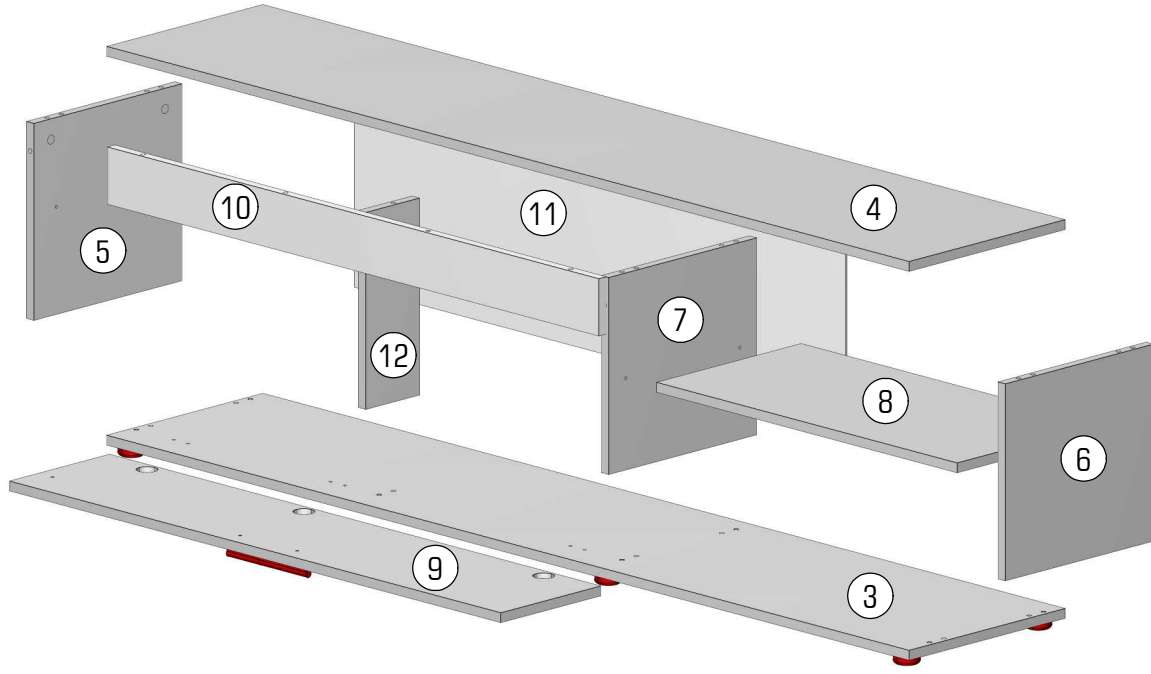
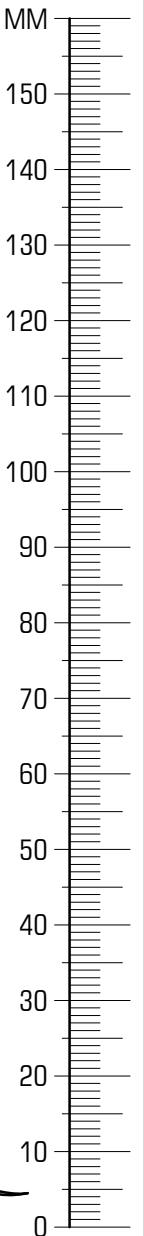

→	1800
↑	371
↘	353
	mm

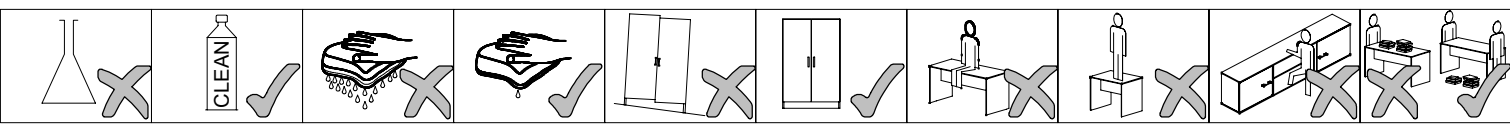

	A	20x	B	7x	C	1x	D	7x	E	7x	F	1x	G	2x	H	3x
	J	3x	K	10x	L	7x	M	6x	N	6x	P	25x	Q	1x	R	4x



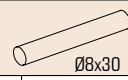

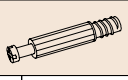
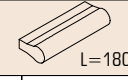
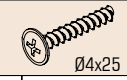
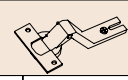
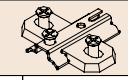
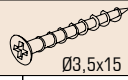
3/13 ASOLE NEW S1

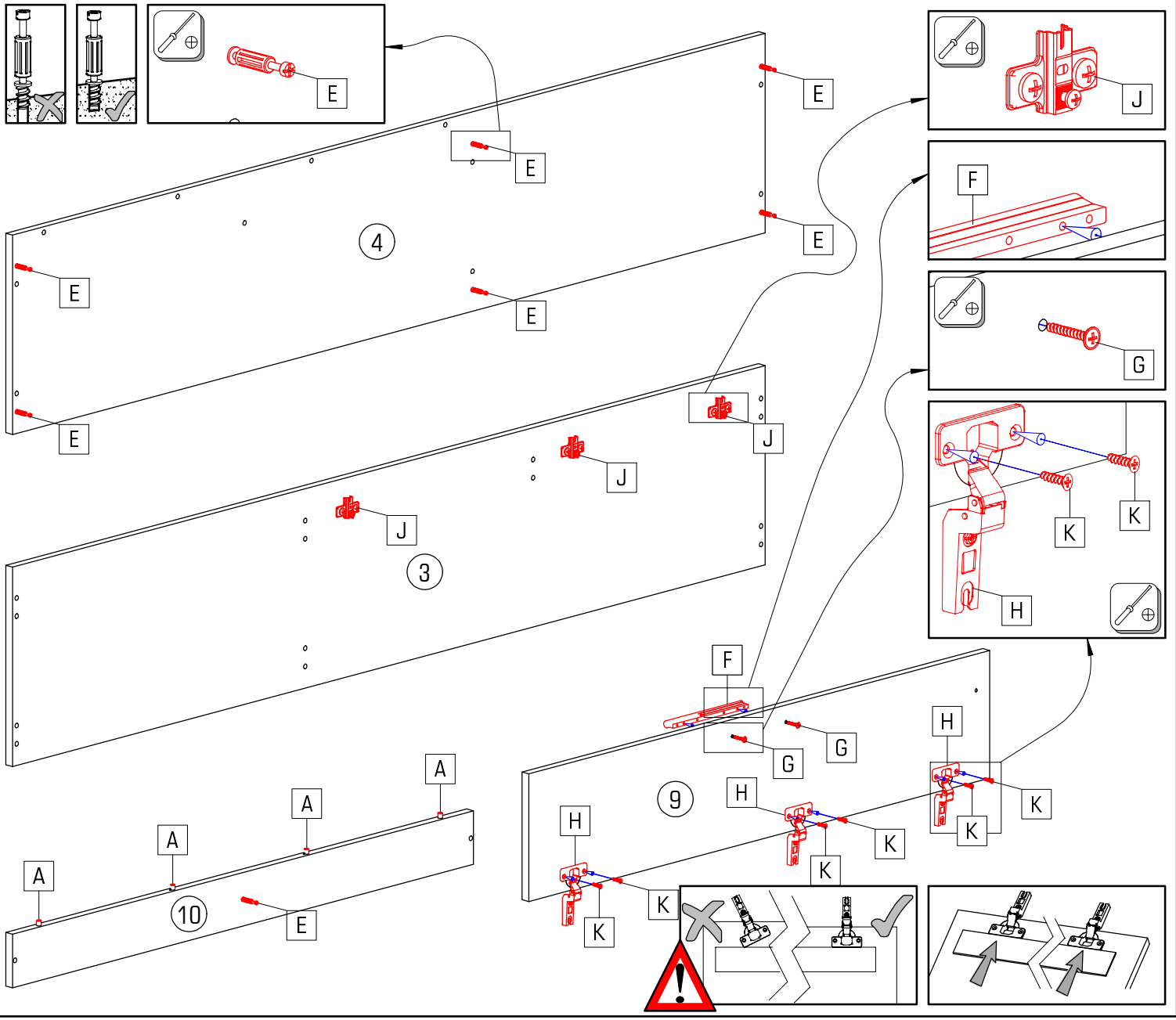
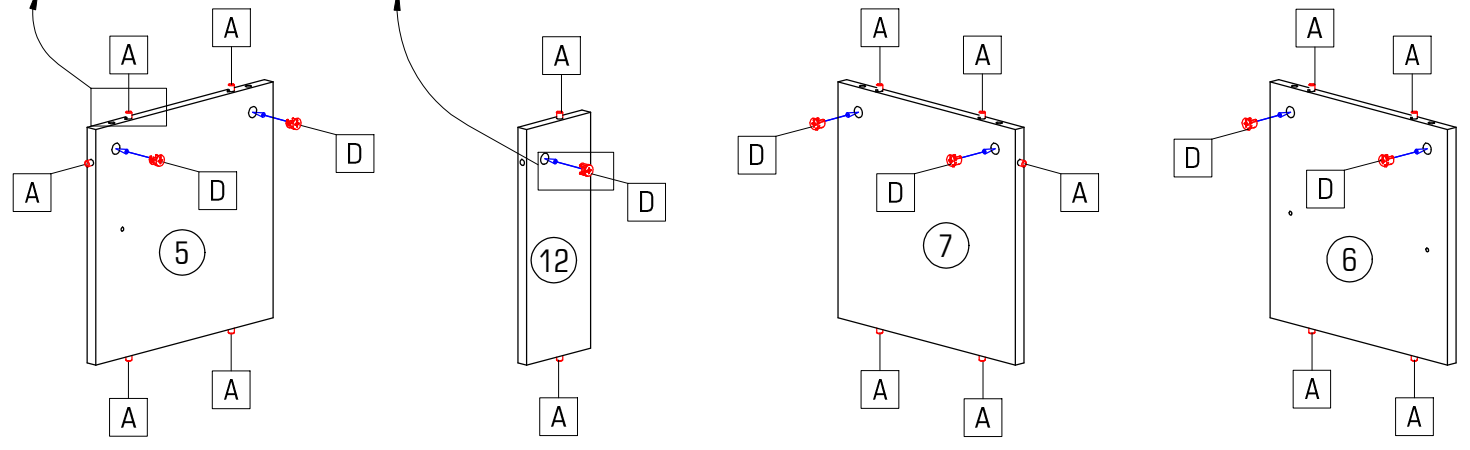
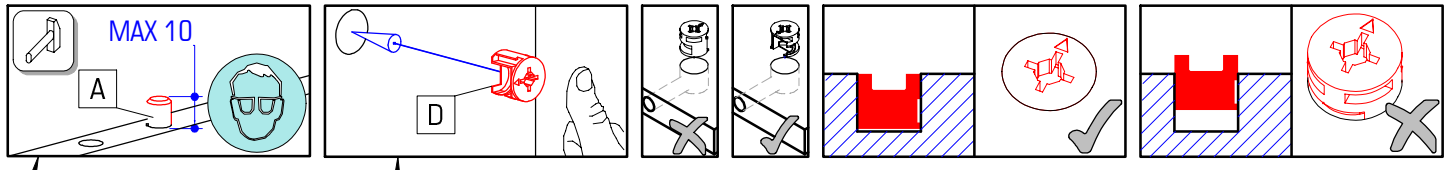
							
A 20x	D 7x	E 7x	F 1x	G 2x	H 3x	J 3x	K 6x

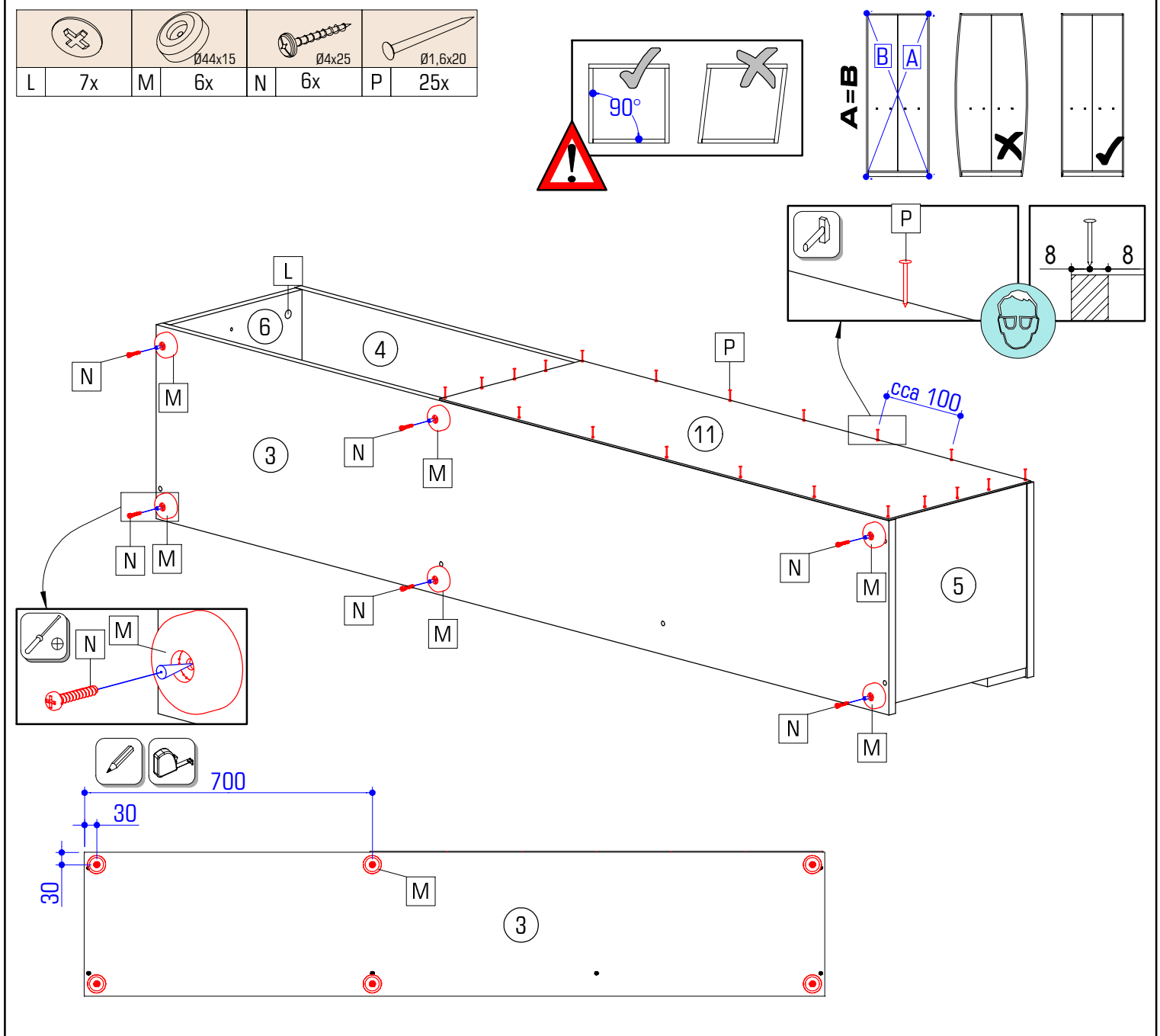
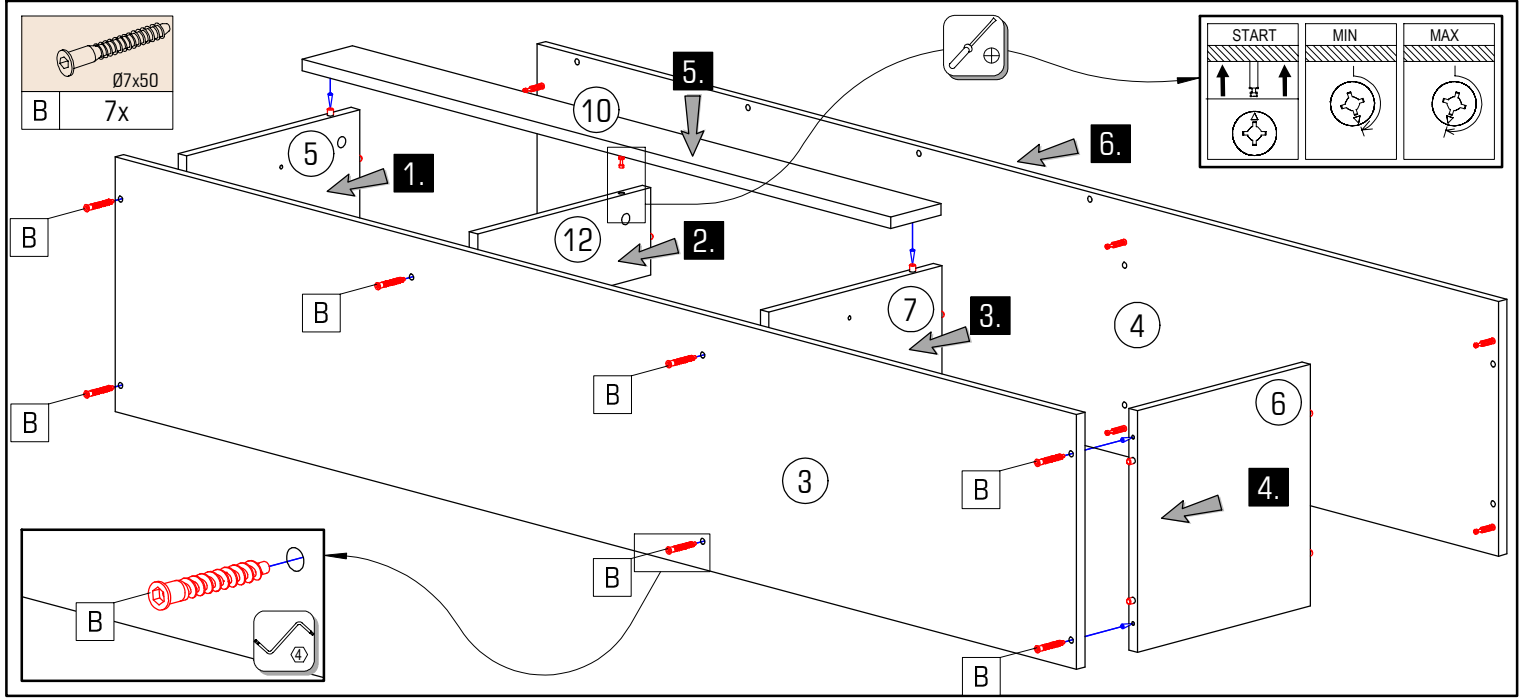

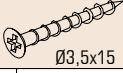

5/13 ASOLE NEW S1

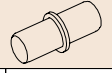
		
Ø3,5x15		
K 4x	Q 1x	R 4x

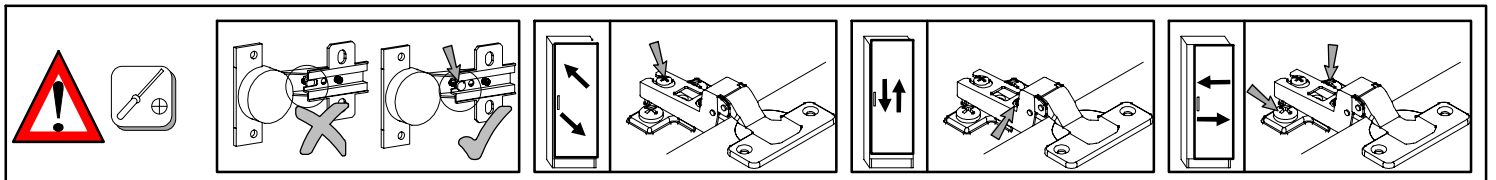
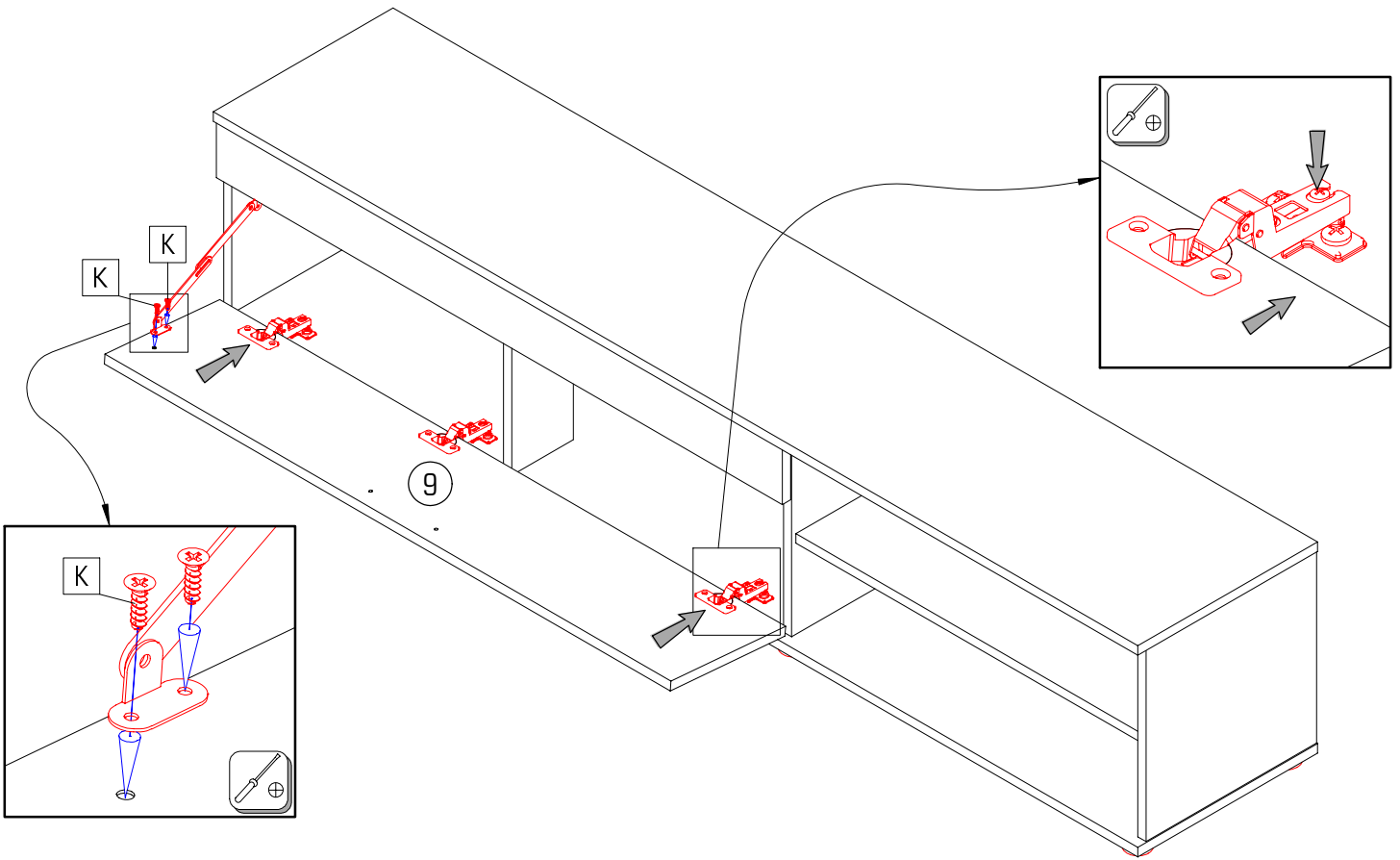
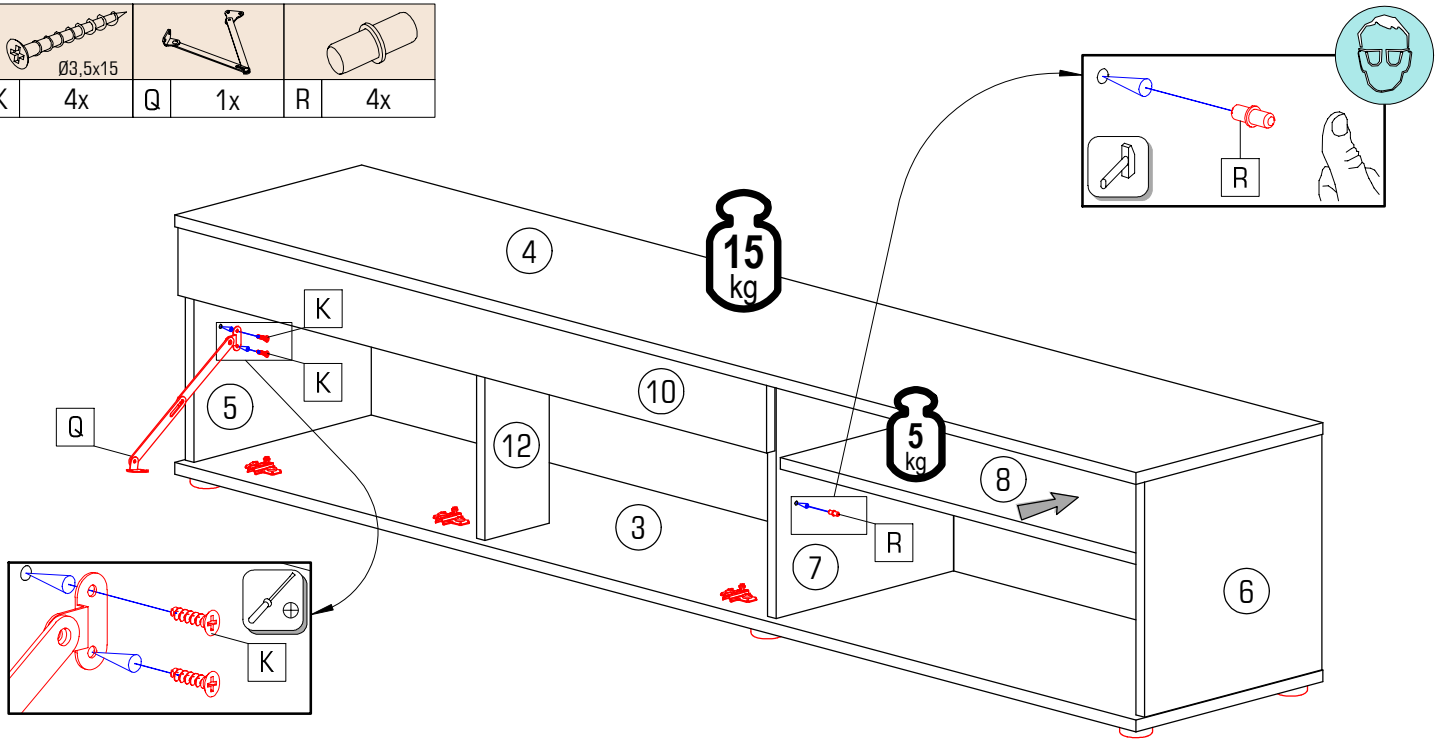

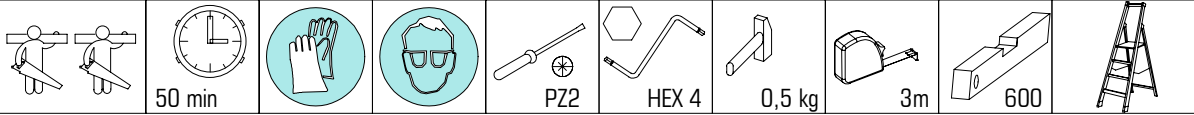

ID EE	ID	Part	Qty	Ratio
16984	14	500*295*16	2x	2/2
16985	15	500*295*16	2x	2/2
16986	16	740*294*16	2x	2/2
16987	17	740*294*16	2x	2/2
16988	18	466*277*16	2x	2/2
16989	19	736*332*16	2x	1/2
16990	20	740*130*16	2x	2/2
16991	21	766*246*3	4x	2/2

↔	500
↑	772
↘	300
	mm

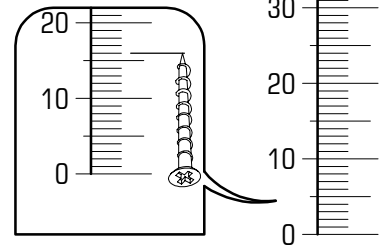
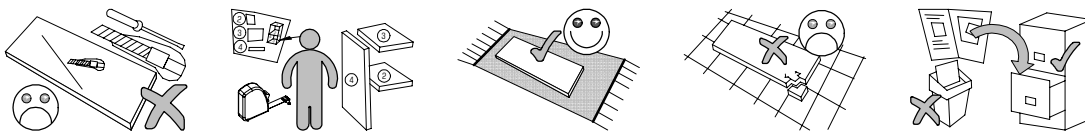
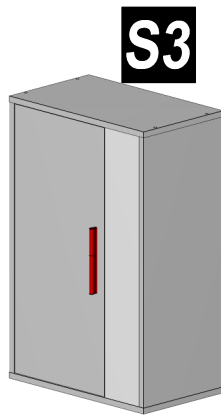
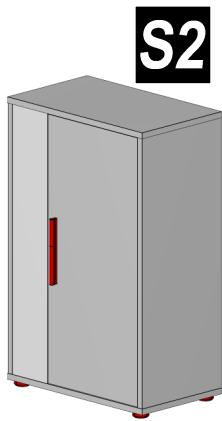
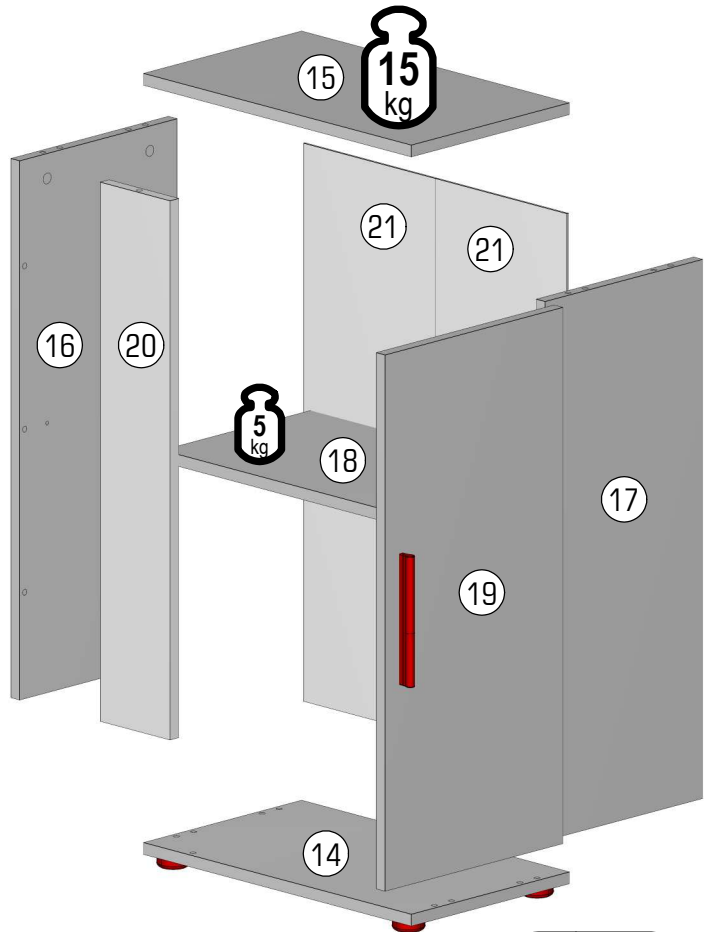
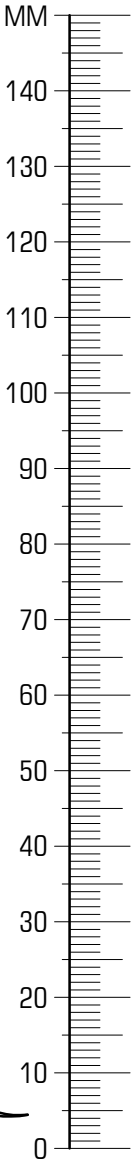

27000.00		26x	A	27000.00		8x	B	22800.01		4	C	70013.01		8x	D	70021.01		8x	E	32029.00		2x	F	22430.00		4x	G	36001.01		4x	H
36001.01		4x	J	22243.00		12x	K			4x	L	30080.00		4x	M	22250.00		4x	N	21102.00		50x	P	35101.01		8x	R	8402.03		2x	S
22206.00		2x	T	22244.01		2x	U	24101.00		2x	V	31103.00		1x	W	24103.00		1x	X	31100.01		2x	Y	22213.00		1x	Z				

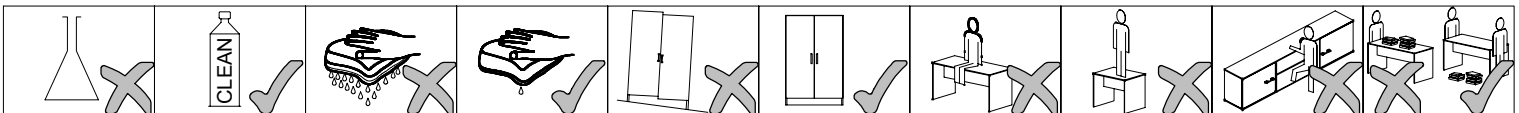

7/13 ASOLE NEW S2; S3

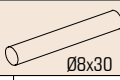
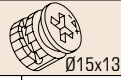
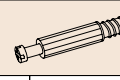
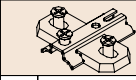
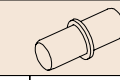
				
A 26x	D 8x	E 8x	J 4x	R 8x

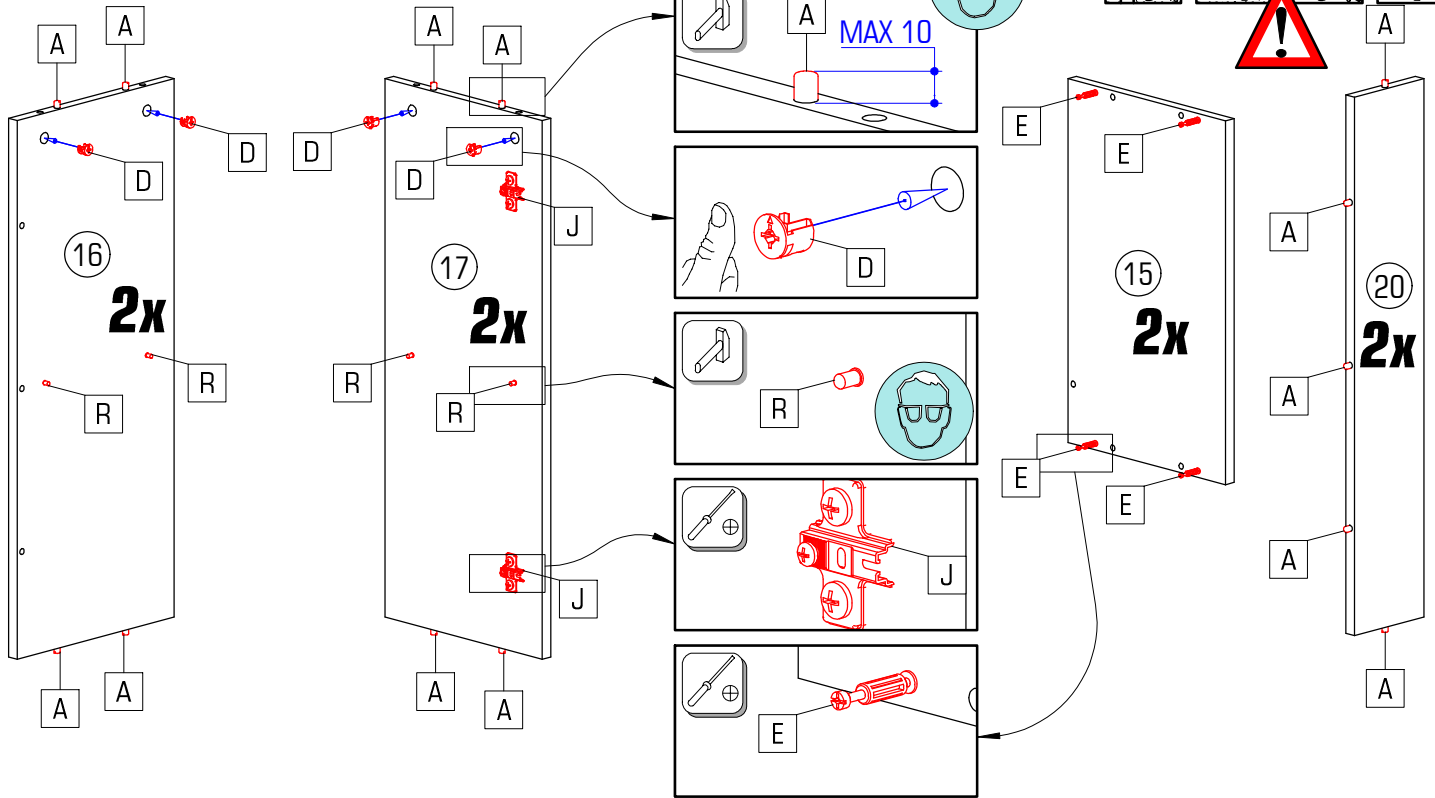
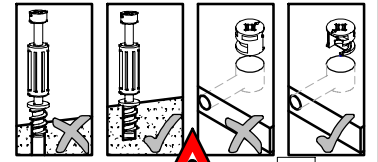

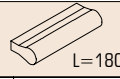
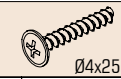
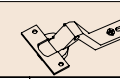
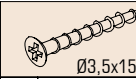
			
F 2x	G 4x	H 4x	K 8x

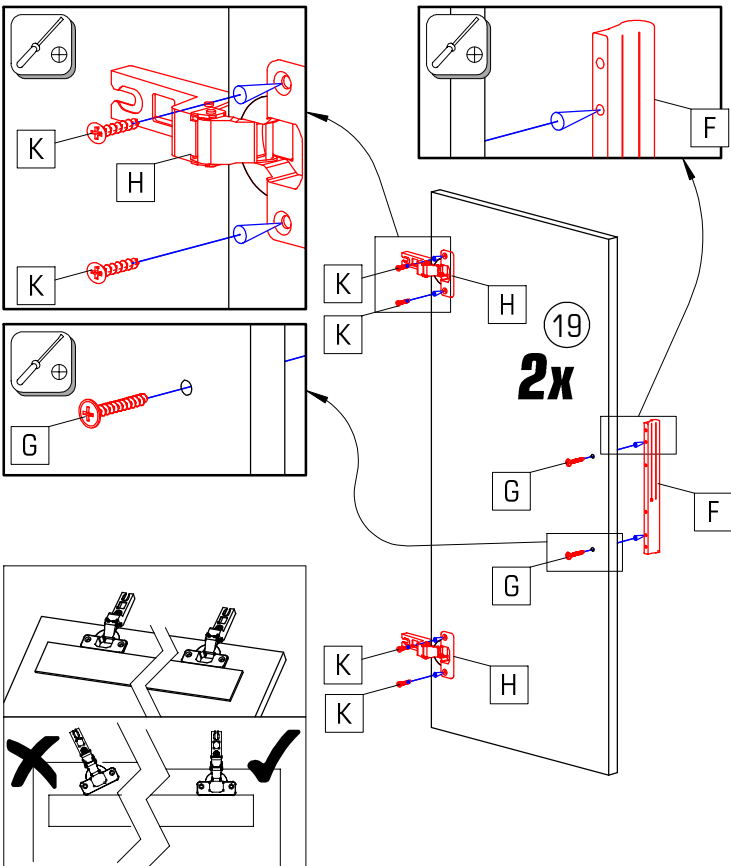

2x

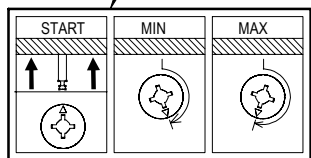
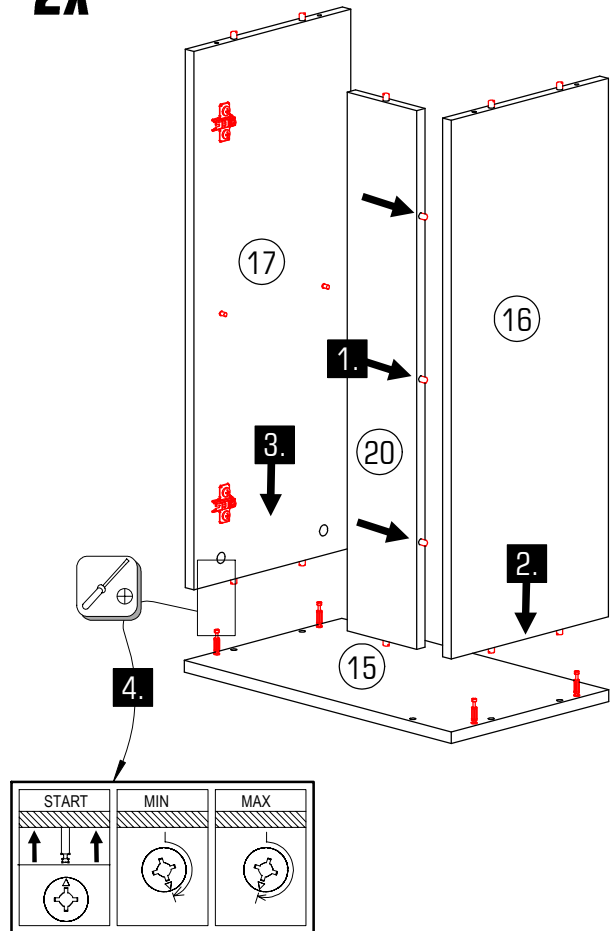

ASOLE NEW S2; S3 8/13

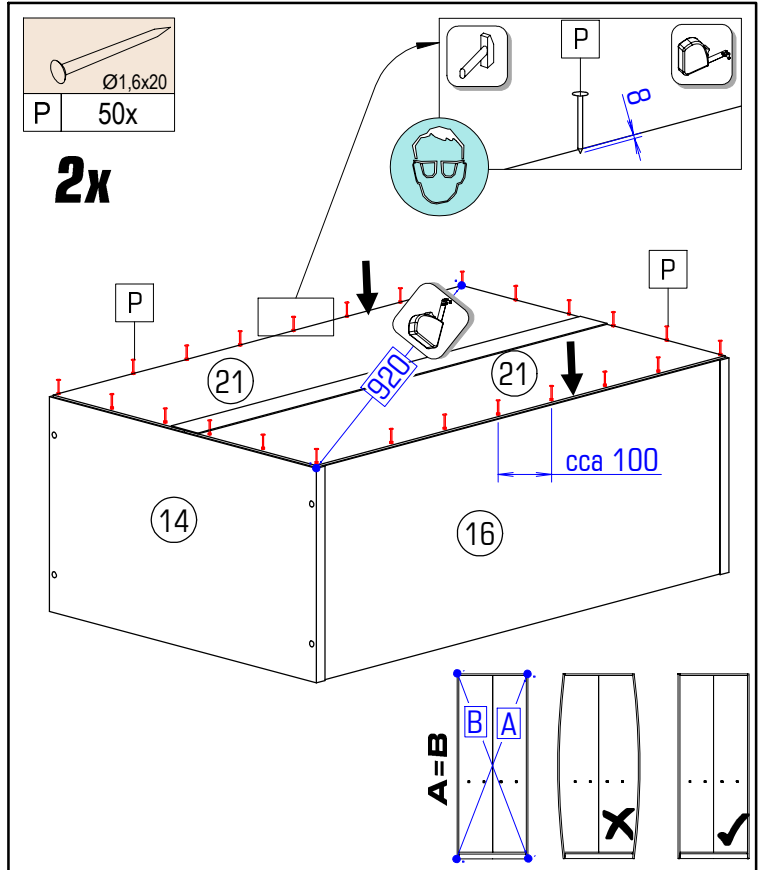
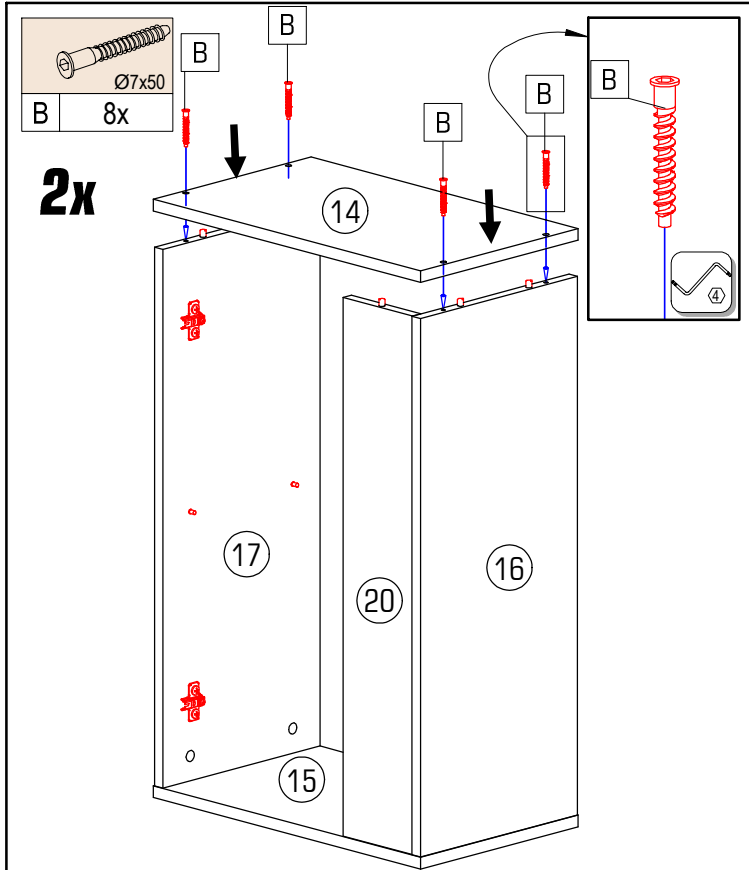

ASOLE NEW S2

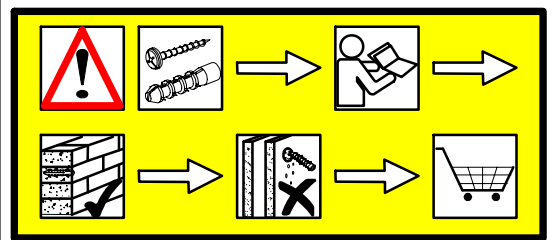
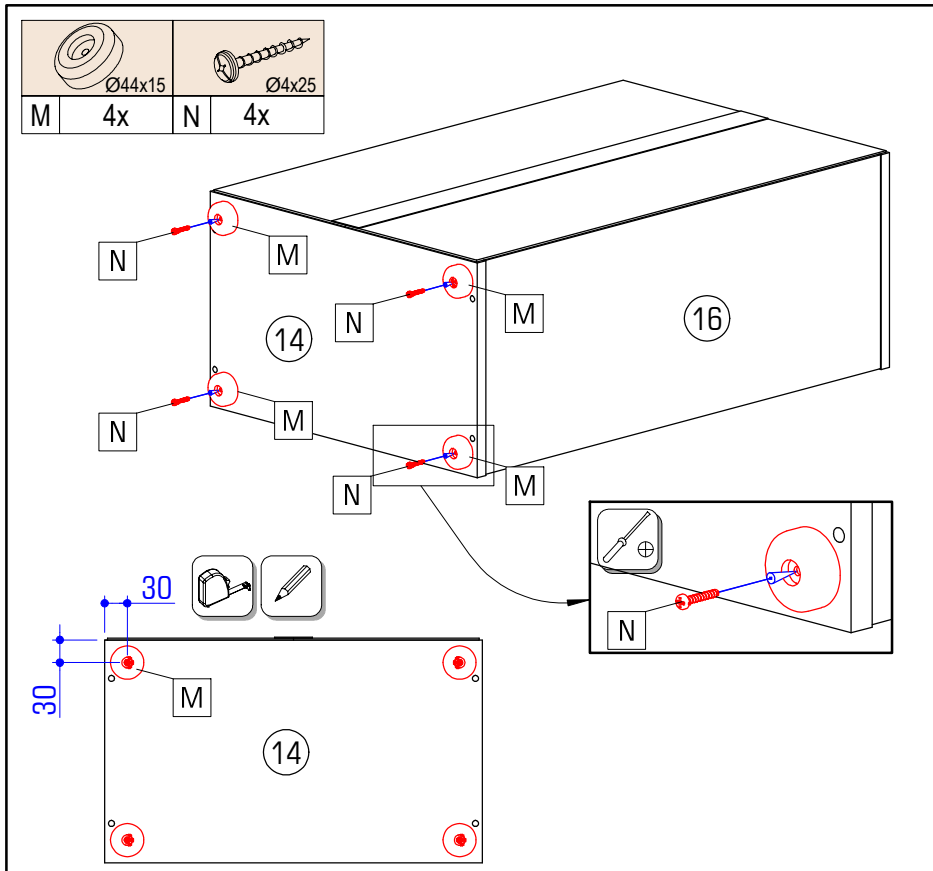

Upozornenie! Pevnosť steny sa musí pred montážou bezpodmienečne skontrolovať. Univerzálne hmoždenky, ktoré sú obsiahnuté v balení, používajte jedine pre pevné murivo ako je betón/tehla. Hmoždenky sa nesmú používať v prípade ľahkého stavebného muriva, dutina tehla, u sádkartónových dosiek alebo iných konštrukcií rámu. U týchto murív je nutné použiť špeciálne hmoždenky! Tieto je možné dostať v špeciálnych predajniach so stavebným materiálom (stavebníny). Pri nedodržaní pokynov nepreberajú výrobcovia/predajci a dodávateľa zodpovednosť za vzniknuté škody.

Upozornění! Před montáží je nutné zkontrolovat stav stěny. Přiložené univerzální hmoždinky jsou určeny pouze k použití pro pevné zdivo jako beton/cihly. Hmoždinky do zdi se nesmí používat u dutinová cihla, zdiva jako pórovitý stavební kámen, sádkartónová deska nebo jiný měkký materiál. U těchto zdív jsou nutné použít speciální hmoždinky! Jsou k dostání v speciálních prodejnách se stavebním materiálem. Při nedodržení těchto pokynů výrobce/prodejce a dovozce neručí za způsobené škody.

Paznja! Prije montaže obvezno provjerite svojstvo zida. Priložene univerzalne tiple namijenjene su isključivo za masivne zidove od betona/opeke. Tiple za masivne zidove ne smiju se koristiti za zidove kao npr šupljina opeka laki sastavni elementi, gips-kartonске ploče ili drugi modularni načini gradnje. Za te zidove potrebne su eventualno specialjne tiple! Iste su dostupne u specijaliziranim trgovinama građevinskim materijalom. U slučaju nepridržavanja prethodno navedenih napomena, proizvođač/trgovac i uvoznik ne preuzimaju odgovornost!

Achtung! Die Wandbeschaffenheit ist vor der Montage unbedingt zu prüfen. Die beigelegten Universaldübel sind ausschließlich nur zur Verwendung für festes Mauerwerk wie Beton/Ziegel. Die Mauerdübel dürfen nicht bei Mauerwerk wie Hohlraumziegel, Leichtbausteinen, Gipskartonplatte oder anderer Rahmenbauweise verwendet werden. Bei diesen Mauerwerken sind gegebenenfalls Spezialdübel zu verwenden! Diese sind in einem Fachgeschäft (Baumarkt) erhältlich. Bei Nichteinhaltung wird seitens Produzenten/Händler und Importeur keine Haftung übernommen.

Prudență! Zidul trebuie examinat înainte de asamblare prizele de perete sunt adecvate numai pentru utilizarea în zidărie fermă, cum ar fi betonul bloc sau cărămidă. Nu folosiți zidăria zidurilor de perete, cum ar fi cărămida goală, blocul ușor, suprafețe cum ar fi gips-carton sau altă încadrare sisteme. Dacă este cazul, trebuie folosite anumite prize de perete! Acestea sunt disponibile la un magazin specializat (magazin de hardware). În caz de nerespectare, producătorul / vânzătorul cu amănuntul sau importatorul nu își asumă răspunderea.

Uwaga! Ścianę należy sprawdzić przed montażem. Dołączone uniwersalne kolki rozporowe są odpowiednie tylko do stosowania w mocnych murach, takich jak beton lub cegła. Nie rób z pomocą kolków rozporowych murowanych, takich jak pustak, lekka kostka, powierzchnie takie jak płyty gipsowo-kartonowe lub inne systemy ram. Jeśli dotyczy, muszą to być określone kolki rozporowe być użyty! Są one dostępne w specjalistycznym sklepie (sklepie ze sprzętem) niezgodność, producent / sprzedawca lub importer nie ponoszą odpowiedzialności.

Vigyázat! Szerelés előtt a falfelületet feltétlenül vizsgálja meg. A mellékelt univerzális tipli kizárólag stabil falazathoz használható mint például beton/tégla. A fal tipli nem használható könnyű építőkövekhez, üreg tégla, gipszkarton lapokhoz vagy más fázvas építményekhez. Ezekhez a falfelületekhez csak speciális tiplik használhatóak, melyek szaküzletekben (barkácsruházakban) beszerezhetőek. Fentiek figyelmen kívül hagyása esetén a gyártó/kereskedő vagy forgalmazó nem vállal felelősséget.

9/13 ASOLE NEW S2

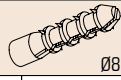
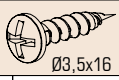
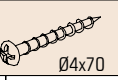
			
W 1x	X 1x	U 2x	Z 1x

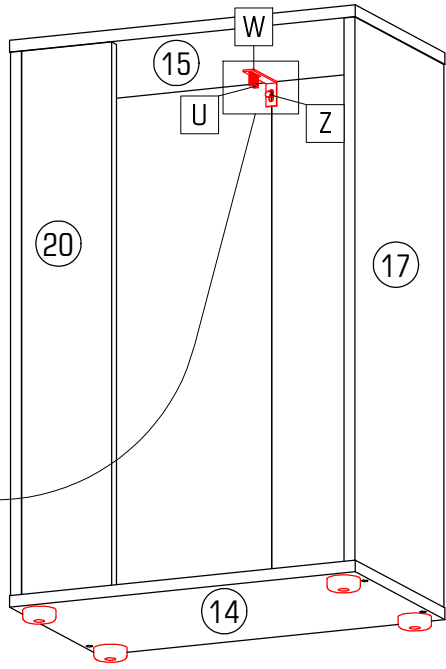
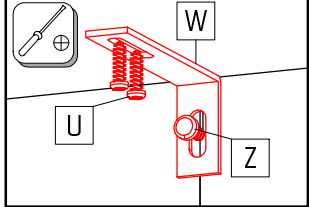
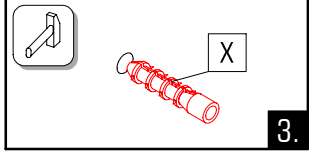
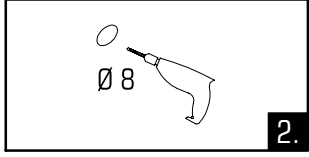
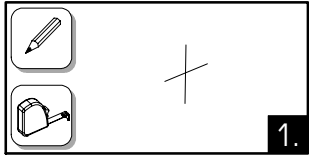



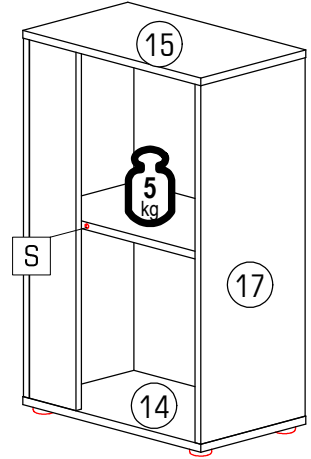
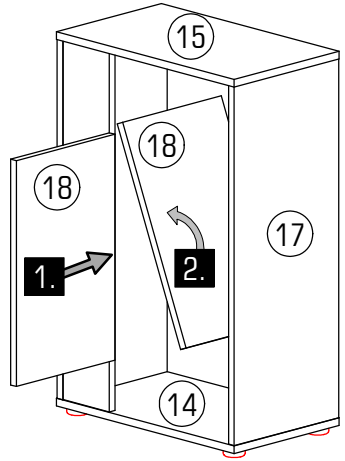

S 1x

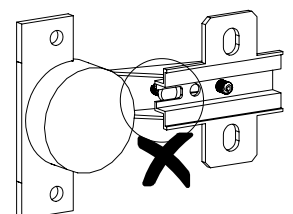
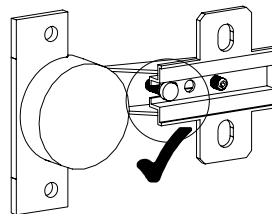
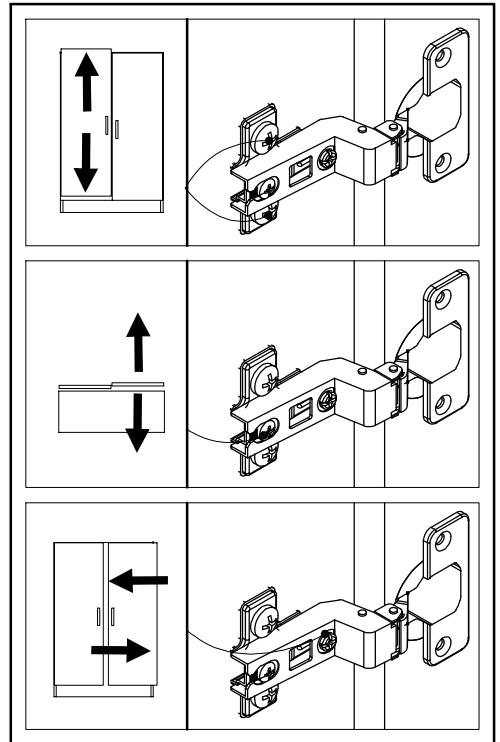
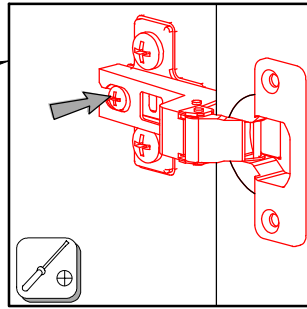
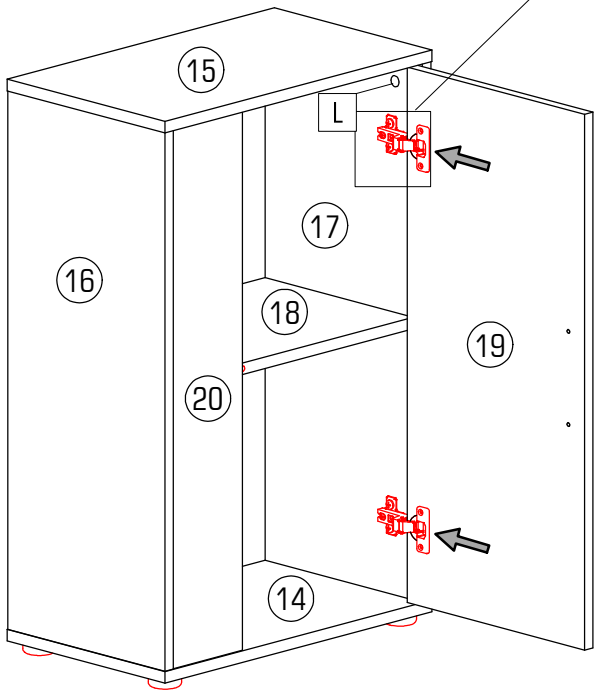

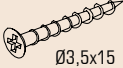

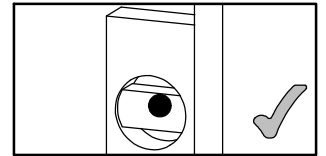
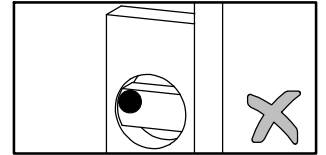
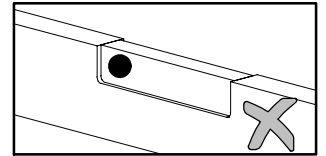
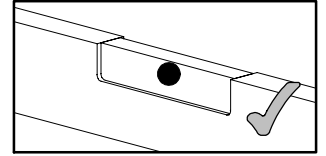
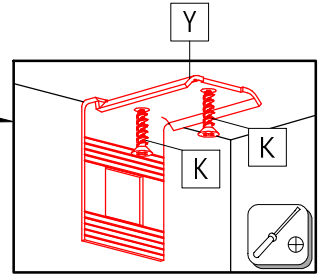
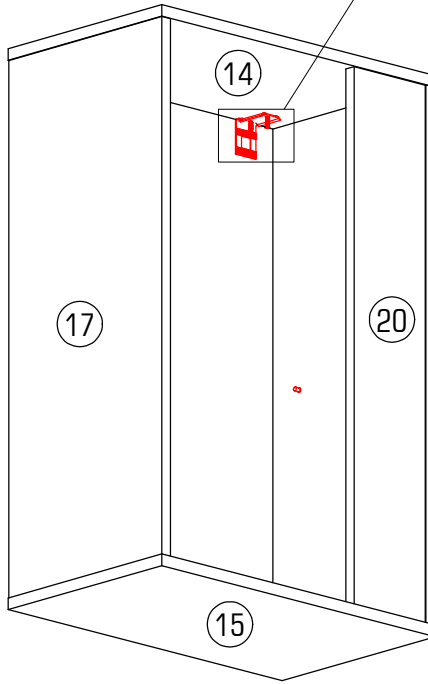
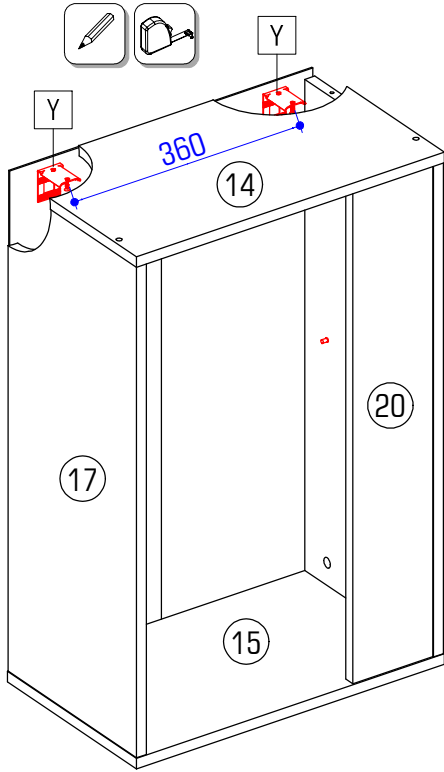

L 2x

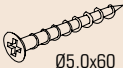

	$\varnothing 3,5 \times 15$	
K	4x	Y
		2x

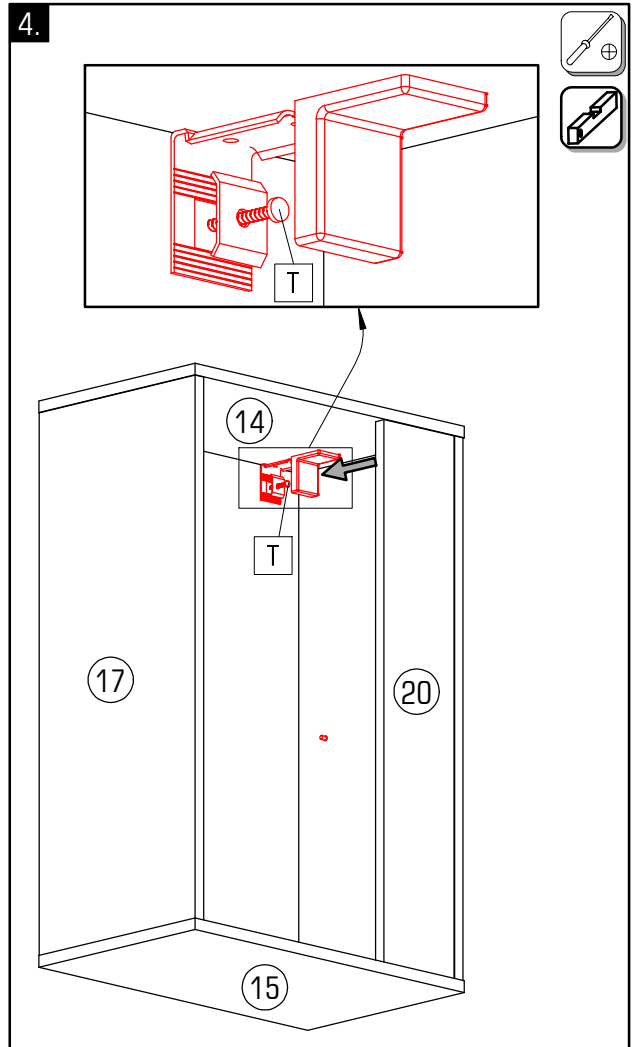
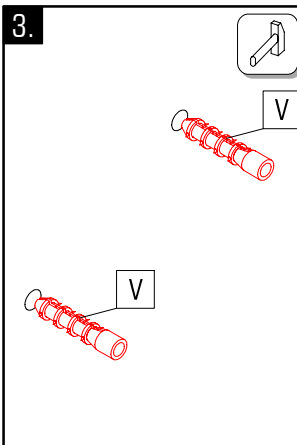
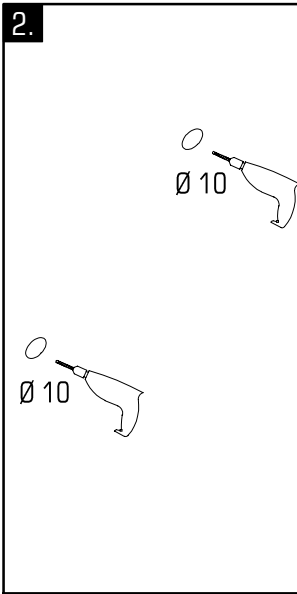
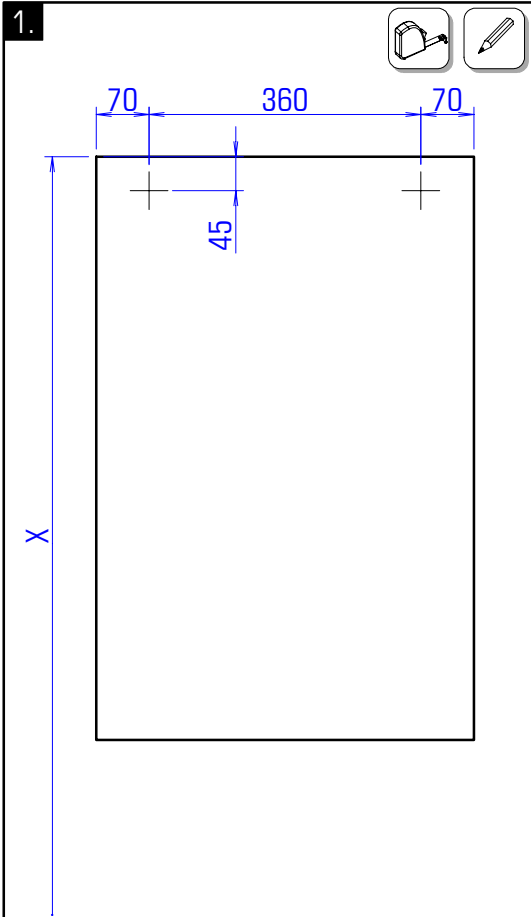

	$\varnothing 5,0 \times 60$		$\varnothing 10$
T	2x	V	2x



11/13 ASOLE NEW S3

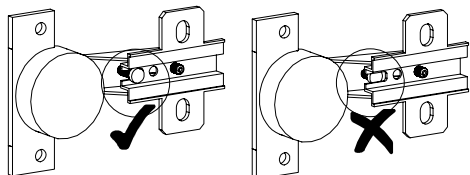
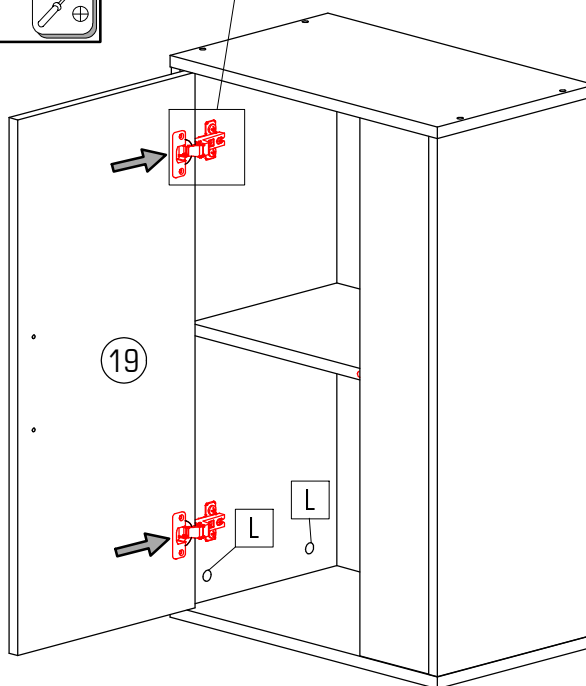
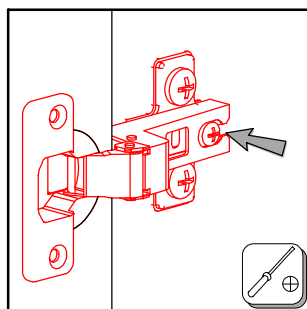
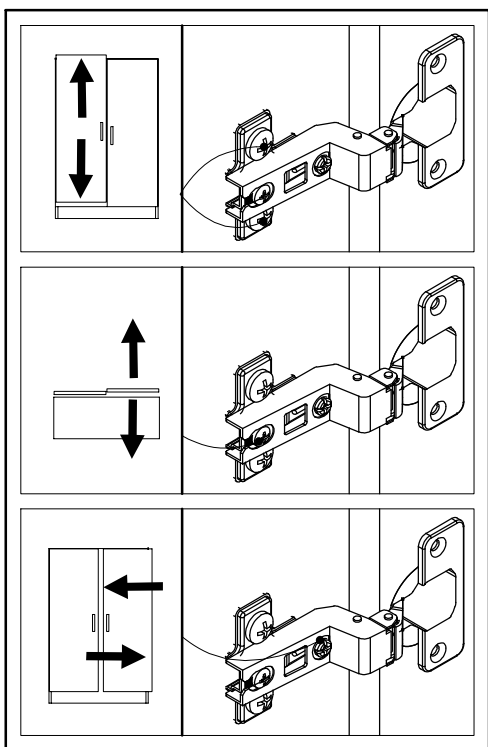
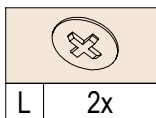
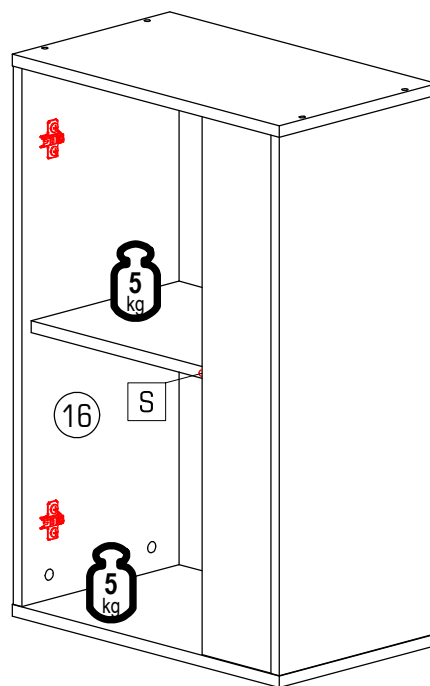
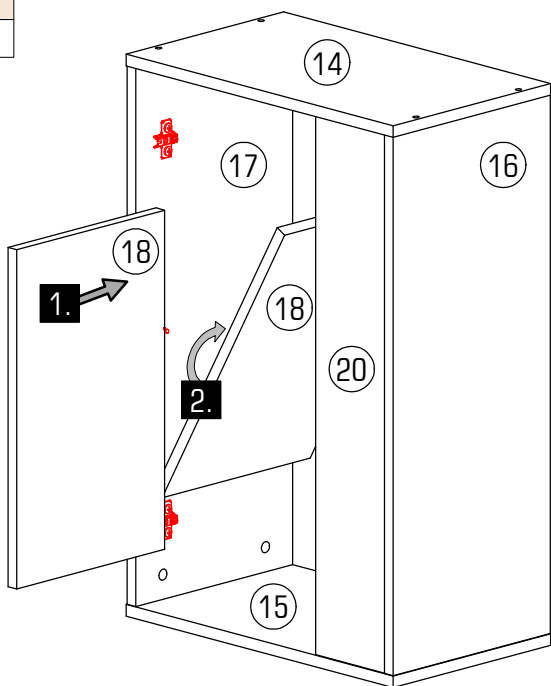
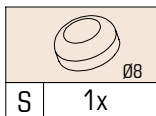

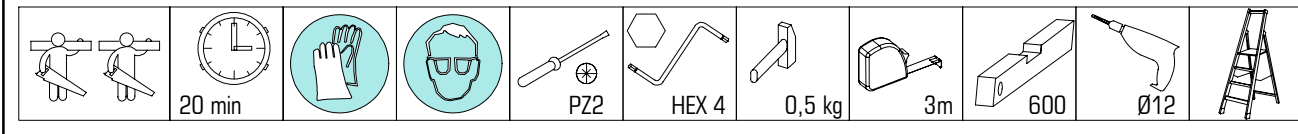

ID	ID			
16992	23	786*80*16	1x	1/2
16993	24	782*155*16	1x	1/2

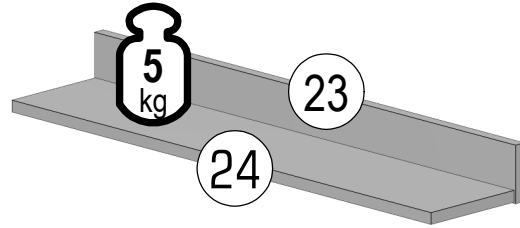

↔	786
↑	80
↗	171
	mm

	22300.00		22705.00		36517.00		70789.00		22800.01		24102.02
A	5x	B	4x	C	2x	D	2x	G	1x	H	2x

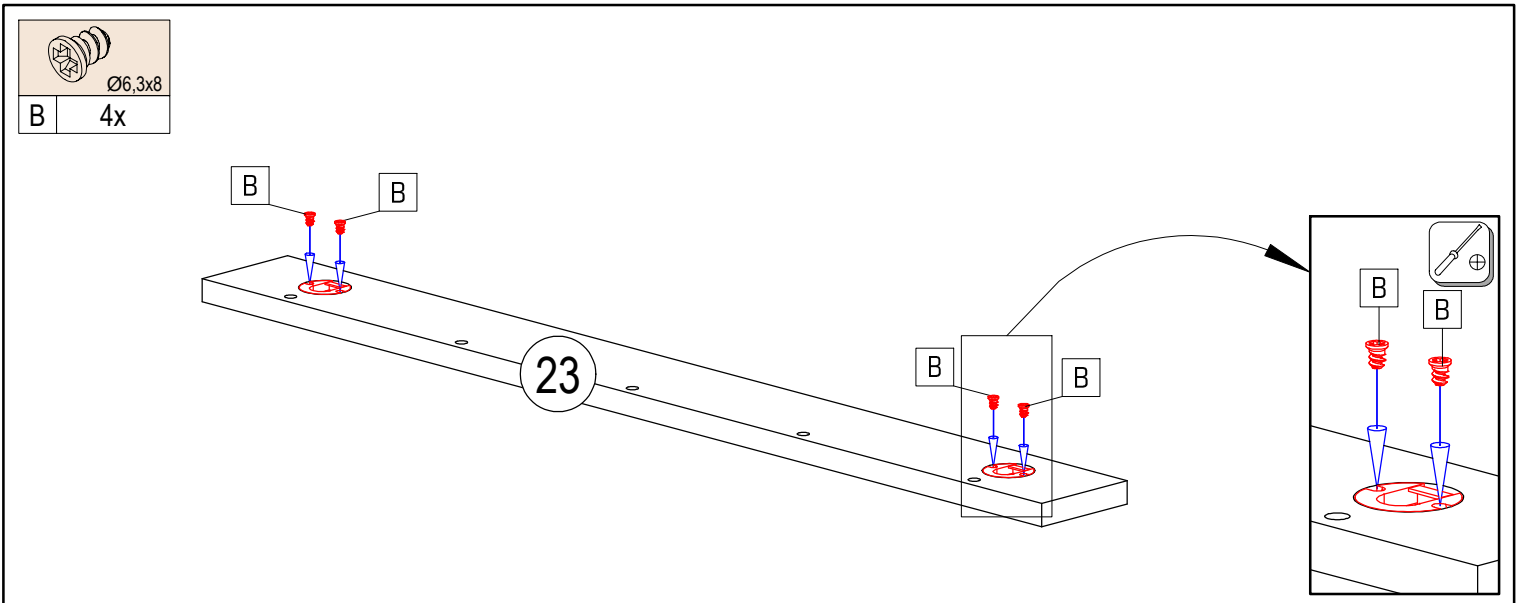
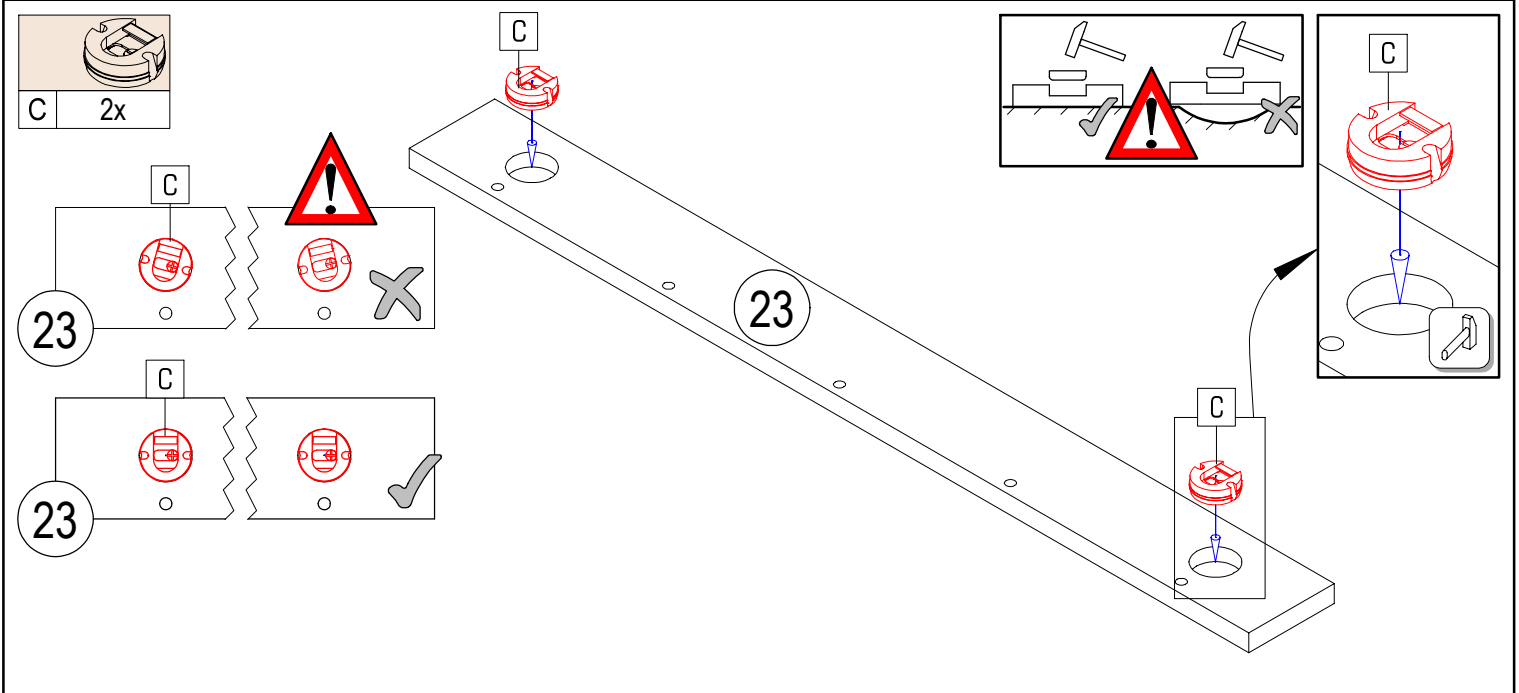
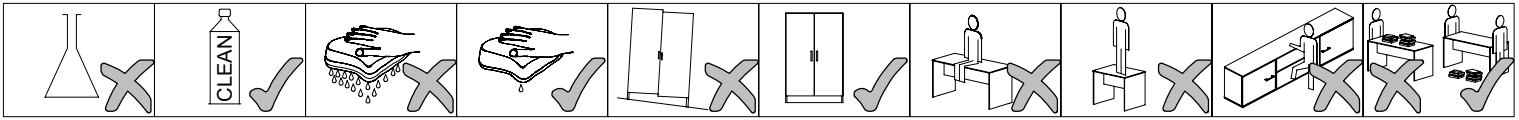

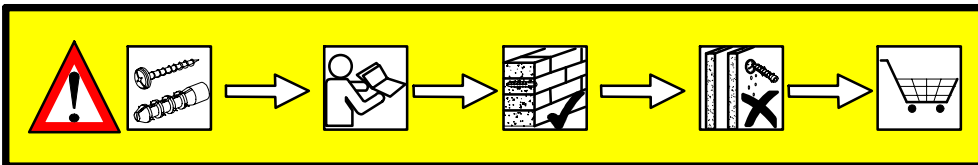
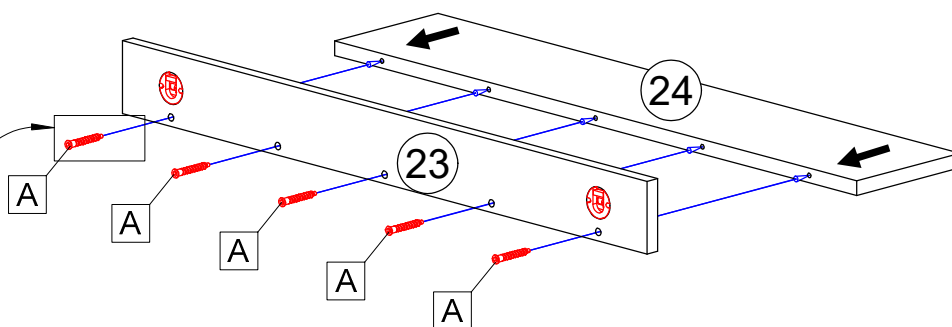
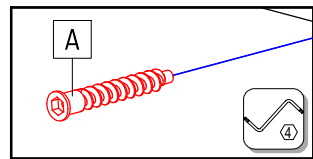
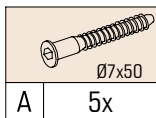

Upozornění! Před montáží je nutné zkontrolovat stav stěny. Příložené univerzální hmoždinky jsou určeny pouze k použití pro pevné zdivo jako beton/cihly. Hmoždinky do zdi se nesmí používat u dutinová cihla, zdiva jako pórovitý stavební kámen, sádrokartonová deska nebo jiný měkký materiál. U těchto zdiv jsou nutné použít speciální hmoždinky! Jsou k dostání v speciálních prodejních se stavebním materiálem. Při nedodržení těchto pokynů výrobce/prodejce a dovozce neručí za způsobené škody.

Pažnja! Prije montaže obvezno provjerite svojstvo zida. Priložene univerzalne tiplje namijenjene su isključivo za masivne zidove od betona/opeke. Tiplje za masivne zidove ne smiju se koristiti za zidove kao npr šupljina opeka laki sastavni elementi, gips-kartonske ploče ili drugi modularni načini gradnje. Za te zidove potrebne su eventualno specialne tiplje! Iste su dostupne u specializiranim trgovinama građevinskim materijalom. U slučaju nepridržavanja prethodno navedenih napomena, proizvođač/trgovac i uvoznik ne preuzimaju odgovornost!

Upozornenie! Pevnosť steny sa musí pred montážou bezpodmienečne skontrolovať. Priložené univerzálne hmoždenky používajte jedine pre pevné murivo ako je betón/tehla. Hmoždenky sa nesmú používať v prípade ľahkého stavebného muriva, dutá tehla, sádrokartónová doska, alebo iných konštrukcií rámu. U týchto stien je nutné použiť špeciálne hmoždenky! Tieto je možné dostať v špeciálnych predajniach so stavebným materiálom. Pri nedodržaní pokynov nepreberajú výrobcovia/predajci a dodávateľa zodpovednosť za vzniknuté škody.

Achtung! Die Wandbeschaffenheit ist vor der Montage unbedingt zu prüfen. Die beigelegten Universaldübel sind ausschließlich nur zur Verwendung für festes Mauerwerk wie Beton/Ziegel. Die Mauerdübel dürfen nicht bei Mauerwerk wie Hohlraumziegel, Leichtbausteinen, Gipskartonplatte oder anderer Rahmenbauweise verwendet werden. Bei diesen Mauerwerken sind gegebenenfalls Spezialdübel zu verwenden! Diese sind in einem Fachgeschäft erhältlich. Bei Nichteinhaltung wird seitens Produzenten/Händler und Importeur keine Haftung übernommen.

Vigyázat! Szerelés előtt a falfelületet feltétlenül vizsgálja meg. A mellékelt univerzális tiplj kizárólag stabil falazathoz használható mint például beton/tégla. A fali tiplj nem használható könnyű építőkövek hez, üreg téglá, gipszkarton lapokhoz vagy más favázás építményekhez. Ezekhez a falfelületekhez csak speciális tiplj használhatóak, melyek szaküzletekben (barkácsáruházakban) beszerezhetőek. Fentiek figyelmen kívül hagyása esetén a gyártó/kereskedő vagy forgalmazó nem vállal felelősséget.

Uwaga! Ścianę należy sprawdzić przed montażem. Dołączone uniwersalne kołki rozporowe są odpowiednie tylko do stosowania w mocnych murach, takich jak beton lub cegła. Nie rób z pomocą kołków rozporowych murowanych, takich jak pustak, lekka kostka, powierzchnie takie jak płyty gipsowo-kartonowe lub inne systemy ram. Jeśli dotyczy, muszą to być określone kołki rozporowe być użytych! Są one dostępne w specjalistycznym sklepie niezgodność, producent / sprzedawca lub importer nie ponoszą odpowiedzialności.

Prudent! Zidul trebuie examinat înainte de asamblare prizele de perete sunt adecvatenumai pentru utilizarea în zidărie fermă, cum ar fi betonul bloc sau cărămidă. Nu folosiți zidăria zidurilor de perete, cum ar fi cărămida goală, blocul ușor, suprafețe cum ar fi gips-carton sau altă încadrare sisteme. Dacă este cazul, trebuie folosite anumite prize de perete! Acestea sunt disponibile la un magazin specializat (magazin de hardware). În caz de nerespectare, producătorul / vânzătorul cu amănuntul sau importatorul nu își asumă răspunderea.

